

Tyre Bay Direct

**FREE
NEXT DAY
DELIVERY**
ON ALL ORDERS OVER £50*



Order now on
0845 900 2130
or **01527 883 580**



INCLUDED



SEE INSIDE FOR:

- TYRE CONSUMABLES
- TYRES & RACKING
- AIR TOOLS & COMPRESSORS
- PREMIUM ITALIAN EQUIPMENT
- ENTRY LEVEL EQUIPMENT
- NITROGEN
- LIFTING EQUIPMENT
- WORKSHOP TOOLS
- WHEEL ALIGNMENT AND MUCH MORE...



Order online at www.tyrebaydirect.com



Knock-on Wheel Weights

Superior performance lead free knock-on wheel weights for both steel and alloy wheels.

Lead Free Weights for Steel Wheels See page 11 for commercial knock-on weights

**TBDW05****TBDW10****TBDW15****TBDW20****TBDW25****TBDW30**

Zinc Wheel Weight for Steel Wheels - 5gm

Zinc Wheel Weight for Steel Wheels - 10gm

Zinc Wheel Weight for Steel Wheels - 15gm

Zinc Wheel Weight for Steel Wheels - 20gm

Zinc Wheel Weight for Steel Wheels - 25gm

Zinc Wheel Weight for Steel Wheels - 30gm

£5.49**£7.89****£8.89****£10.99****£12.94****£14.92****TBDW35****TBDW40****TBDW45****TBDW50****TBDW55****TBDW60**

Zinc Wheel Weight for Steel Wheels - 35gm

Zinc Wheel Weight for Steel Wheels - 40gm

Zinc Wheel Weight for Steel Wheels - 45gm

Zinc Wheel Weight for Steel Wheels - 50gm

Zinc Wheel Weight for Steel Wheels - 55gm

Zinc Wheel Weight for Steel Wheels - 60gm

£9.68**£10.89****£12.99****£13.69****£15.49****£15.95**

Box of 100

Box of 50

Lead Free Weights for Alloy Wheels

**TBDC05****TBDC10****TBDC15****TBDC20****TBDC25****TBDC30**

Zinc Wheel Weight for Alloy Wheels - 5gm

Zinc Wheel Weight for Alloy Wheels - 10gm

Zinc Wheel Weight for Alloy Wheels - 15gm

Zinc Wheel Weight for Alloy Wheels - 20gm

Zinc Wheel Weight for Alloy Wheels - 25gm

Zinc Wheel Weight for Alloy Wheels - 30gm

£6.99**£8.49****£10.59****£12.79****£14.99****£15.99**

Box of 100

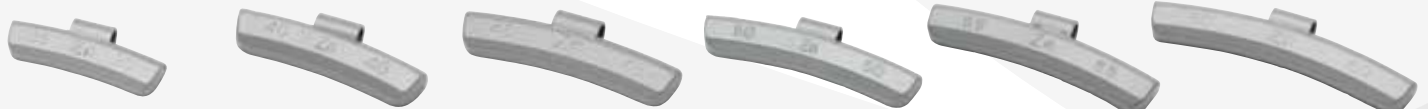
**TBDC35****TBDC40****TBDC45****TBDC50****TBDC55****TBDC60**

Zinc Wheel Weight for Alloy Wheels - 35gm

Zinc Wheel Weight for Alloy Wheels - 40gm

Zinc Wheel Weight for Alloy Wheels - 45gm

Zinc Wheel Weight for Alloy Wheels - 50gm

Zinc Wheel Weight for Alloy Wheels - 55gm

Zinc Wheel Weight for Alloy Wheels - 60gm

£9.65**£10.89****£11.99****£12.49****£13.49****£16.34**

Box of 50

Tools

**TBDTR07**

Value Universal Weight Pliers

£7.49**TBDWWP1**

Premium Draper Universal Weight Pliers

£13.80**TBD085**

Self Adhesive Weight Removal Tool

£3.49

SPECIAL WEIGHT PACK ONLY **£53.99** **TBDSWP**

Knock on Weights for Steel Wheels 5g - 20g (100 of each)
Knock on Weights for Alloy Wheels 5g - 20g (100 of each)

**SAVE
OVER
25%**



**STAR
BUY**

Self Adhesive Weights

High quality self adhesive wheel weights available in rolls or strips, matt or polished, all at incredible prices.

BEST SELLER



TBDA02NFE

Self Adhesive Weights in 5g+10g Sections.
60g Per Strip. 50 Strips Per Box.

£6.99

Reduced from £8.49!

BULK BUY OFFER



TBDA02NFE x5

Self Adhesive Weights in 5g+10g Sections.
60g Per Strip. 250 Strips in Total.

£29.99*

*Save over 14% when bulk buying 5 boxes of TBDA02NFE. Maximum of 5 boxes per order.

Lead Free Self Adhesive Weights

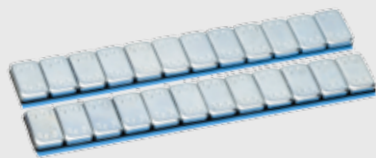

TBDA04

Self Adhesive Weights in 5g Sections.
60g Per Strip. 50 strips per box.

£6.99

Reduced from £8.49!



TBDA04 x5

Self Adhesive Weights in 5g Sections.
60g Per Strip. 250 strips in total.

£29.99*

*Save over 14% when bulk buying 5 boxes of TBDA04.
Maximum of 5 boxes per order.



TBDA04B

Black Self Adhesive Weights in 5g Sections.
60g Per Strip. 50 strips per box.

£8.79

Weight Rolls

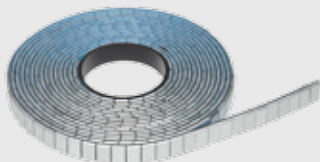

TBDA03-2.6KG

Self Adhesive Weight Roll in 5g Sections.
2.6kg Per Roll

£8.49

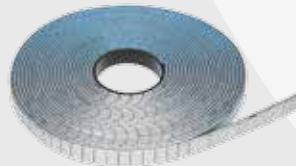

TBDA03-5KG

Self Adhesive Weight Roll in 5g Sections.
5g Per Roll

£13.99



TBDA07

Self Adhesive Weight Dispenser

£15.99

Motorcycle Weights



TBDA05

Self Adhesive Lead Weights for Motorcycles in 2.5g+5g Sections. 50g Per Strip. 100 strips per box.

£24.99

Extra Value Weight Pack ONLY £119.99 SWPA

SAVE OVER 17%

- Knock on Weights - Steel Wheels 5g - 30g (100 of each)
- Knock on Weights - Alloy Wheels 5g - 30g (100 of each)
- Self Adhesive Weights (100 strips)



Tyre Valves

High quality TUV certified snap-in tyre valves for 11.5mm rim holes.

Tubeless Snap-in Tyre Valves



Motorcycles

TR412

22mm Length Snap-in Tyre Valve

£11.99



TR413

30mm Length Snap-in Tyre Valve

£9.99



Short

TR414

38mm Length Snap-in Tyre Valve

£8.49



TR414L

45mm Length Snap-in Tyre Valve

£11.99



Long

TR418

49mm Length Snap-in Tyre Valve

£11.99

Bag of 100

Tubeless Snap-in Tyre Valves with Half Length Chrome Sleeves



TR413C

TR413 Valve with Chrome Sleeve

£19.99



TR414C

TR414 Valve with Chrome Sleeve

£19.99



TR418C

TR418 Valve with Chrome Sleeve

£19.99

Bag of 100

Tubeless Snap-in Tyre Valves with Full Length Chrome Sleeves



TR413AC

TR413 Valve with Chrome Sleeve

£21.99



TR414AC

TR414 Valve with Chrome Sleeve

£21.99



TR418AC

TR418 Valve with Chrome Sleeve

£21.99

Bag of 100

Tubeless Snap-in Tyre Valves

Have your company name and number on every tyre valve you sell so your customers never forget where to go for their tyres!

Give these customised keyrings to your customers as a thank you promotional gift and enjoy the repeat business.



TBDCUSTTR413

Customised TR413 Valves

£10.99

TBDCUSTTR414

Customised TR414 Valves

£13.99

TBDCUSTTR418

Customised TR418 Valves

£15.99

TBD414AC-CUST

Customised Chrome TR414 Valves

£24.99

TBDTR418AC-CUST

Customised Chrome TR418 Valves

£29.95

TBDCKRB

Promotional Tyre Valve Keyring in Black

£15.99

TBDCKRMIX

Promotional Tyre Valve Keyrings in Coloured Chrome

£27.99

Bag of 100

TECH300 Professional TPMS Activation & Diagnostic Tool

The TECH300 is a professional and easy to use tool designed to activate and diagnose TPMS faults. Compatible with all TPMS cars, OE sensors and major programme sensors, this model is an ideal investment for your garage. Once the sensors have been detected and read, simply connect to your computer via the USB cable or Bluetooth and upload the vehicle test data. The tool is also EOBD capable for vehicle diagnostics.

The **TECH300** Includes

- Tool
- User manual
- Universal charger
- Bluetooth dongle
- USB cable
- Tool case

TECH300 £899



NOW WITH A **FREE** PCL TPMS REPAIR KIT!



BARTEC
AUTO ID

Specialist Valves & Hand Tools

Specialist tyre valves from as little as 39p and hand tools from as little as 99p!

Specialist Tyre Valves & Accessories



TR415

32mm Snap-in Tyre Valve for 15.7mm rim holes x25

£3.15



TR218A-1

110mm Diameter Air Water Valve for Agricultural Inner Tubes

£1.99



525M-

Bolt-in Metal Tyre Valve for 11.5mm rim holes

£1.99



E600R

High Pressure Snap-in Tyre Valve for 11.5mm rim holes

£0.39



TBD2612B

90 Degree Metal Tyre Valve for 11.5mm rim holes

£0.79



FLUSHFIT

Set of 4 Flush Fit Tyre Valves with Airline Adaptor

£3.99

Each

Valve Tools



TBD004

4 in 1 Tyre Valve Tool

£0.99



TBD019

Valve Core Removal Key

£0.99



TBD019B

Core Removal Key Extended Shank

£1.49



TBD019C

Core Removal Key Double Ended

£1.49



TBD110

Tyre Valve Fishing Tool

£3.49



TBD005C

Quick Insert Tyre Valve Mounter

£3.99

Each



TBD005

Plastic Screw-on Tyre Valve Mounter

£3.99



TBD005B

Metal Screw-on Tyre Valve Mounter

£4.99



TBDTR06A

Tyre Valve Knife with Tapered Blade

£4.99



TBDTR06B

Tyre Valve Knife with Hooked Blade

£3.99



TBDTR06C

Tyre Valve Knife with Rounded Blade

£3.49

Each

Valve Caps



VC8BL-

Black Plastic Tyre Valve Dust Caps

£3.00



VC8G

Green Plastic Tyre Valve Dust Caps

£2.00



VC8CH-1

Chrome Tyre Valve Dust Caps

£9.00

Bag of 100

Hand Tool Value Pack

Hand Rasp, Spiral Cement Tool, Stitch Roller, Valve Knife with Tapered Blade, Valve Knife with Hooked Blade, Universal Weight Pliers, Self Adhesive Weight Remover, Tyre Valve Tool, Tyre Prodder, Rubber Scraper, Insert Tool, Shoe Handled Wire Brush (one of each)



HTSP ONLY £19.99

Repair Tools and Accessories



TBDTR17B

2 in 1 Hand Rasp and Cement Tool (T Handle)

£2.99



TBDTR17C

2 in 1 Hand Rasp and Cement Tool (Straight Handle)

£2.99



TBDTR17

Hand Rasp

£3.99



TBDTR34-

Tyre Prodder

£3.49



TBDTR17A

Spiral Cement Tool

£2.99



TBDTR35

Rubber Scraper

£2.29



TBD016C-

Plastic Handled Wire Brush

£2.99



TBD016A

Shoe Handled Wire Brush

£2.99



TBDTR11

Stitch Roller

£3.99



TBDTR18

Repair String Insert Tool with Slit in Eye

£1.99

Repair Tools & Chemicals

Air Powered Buffing Tools and Accessories

See page 12 for more air tools



FDGKIT

Air Powered Buffing Tool

£17.99



TBDTR05

Spherical 'Golf Ball' Buffing Stone

£2.49



TBDTR38

Grit Flap Wheel

£3.99



TBDTR36A-B

3mm Carbide Cutter

£10.99



TBDTR36B-B

6mm Carbide Cutter

£14.29



TBDTR36C-0

8mm Carbide Cutter

£19.99



TBDTR36D-2

10mm Carbide Cutter

£26.99



TBDTR36C

6mm Steel Cutter

£6.99



TBD342P

6mm Brass Plated Wire
Brush 100mm Diameter

£2.99



TBD349P

6mm Twist-Knot Wire
Brush 75mm Diameter

£8.95



TBD077-M

Bench Top Tyre Spreader

£39.99



TBD077P

Pneumatic Tyre Spreader

£79.99

Repair Chalk



TBD006A

White Tyre Marking
Chalk (Box of 12)

£4.99

TBD006B

Yellow Tyre Marking
Chalk (Box of 12)

£4.99

TBDTR41-2

Tyre Dusting Chalk

£1.99

10 Piece Tyre Buffer Set

Light duty machine giving complete flexibility for most grinding needs. Ideal for grinding and polishing metal components. Supplied complete in carrying case.



FS40BK

**STAR
BUY**

ONLY £21.99

Repair Chemicals



TBDTRH34

Fast Dry Vulcanising
Solution (250ml)

£3.94



TBDTRH35

Fast Dry Vulcanising Solution
(1 litre)

£11.99



TBDTRH36

Heavy Duty Blue Vulcanising
Solution (250ml)

£4.49



TBDTRH37

Heavy Duty Blue Vulcanising
Solution (1 litre)

£12.99



TBDTR04-1

Bead Sealer with Brush
(950ml)

£7.99



TBDTR09

Liquid Rubber Buffer Cleaner (1 litre)

£3.89



TBDTR09A-2

Rubber Buffer Cleaner Spray (500ml)

£4.49



TBDTR32

Leakfinder (1 litre)

£2.79



TBDTR33-2

Inner Liner Sealant (500ml)

£9.99

Repair Materials

High quality repair materials and chemicals for professional puncture repairs.

Plugs

Repair plugs are designed to repair the tread area of radial and cross ply tyres.



- TBDTRH30** 4mm Repair Plug x24 **£9.84**
- TBDTRH31** 6mm Repair Plug x24 **£10.99**
- TBDTRH32** 9mm Repair Plug x24 **£15.39**
- TBDTRH33** 14mm Repair Plug x24 **£23.99**

String

Repair string is classified as a temporary repair and should be permanently repaired as soon as possible.



- TBDTR31C-1** 4" Thin String x120 **£6.99**
- TBDTR31C-N** 8" Thin String x60 **£6.99**
- TBDTR31D-N** 12" Thin String x60 **£8.79**
- TBDTR31A-1** 4" Thick String x60 **£4.99**
- TBDTR31B-1** 8" Thick String x30 **£4.99**

Universal Patches

Universal patches are used to repair small injuries to tubeless, radial and cross ply tyres.



- TBDTRH01** 35mm Universal Patch x80 **£5.99**
- TBDTRH02** 45mm Universal Patch x60 **£7.69**
- TBDTRH03** 55mm Universal Patch x50 **£8.99**

Tube Patches

Tube patches are designed to repair injuries to inner tubes.



- TBDTRH08** 25mm Patch x100 **£3.95**
- TBDTRH10** 35mm Patch x80 **£3.45**
- TBDTRH12** 45mm Patch x40 **£3.69**
- TBDTRB13** 60mm Patch x30 **£4.49**
- TBDTRH16** 80mm Patch x20 **£7.49**

Radial Patches

Radial patches are used for durable repairs to radial tyres.



- TBDTRH45** 45x75mm Patch x20 **£8.99**
- TBDTRH26** 75x125mm Patch x10 **£15.99**
- TBDTRH001** 100x125mm Patch x10 **£22.65**
- TBDTRH52** 125x250mm Patch x10 **£48.99**

Cross Ply Patches

Cross ply patches are designed for durable repairs to cross ply tyres.



- TBDTRH23** 75mm Patch x20 **£7.99**
- TBDTRH24** 100mm Patch x10 **£8.99**
- TBDTRH25** 130mm Patch x10 **£11.99**
- TBDTRH27** 165mm Patch x10 **£14.99**
- TBDTRH07** 240mm Patch x5 **£18.95**

Value Tyre Repair Kit

ONLY £24.99

VRKH10

The Value Tyre Repair Kit contains 60x 45mm Universal Repair Patches, 24x 6mm Stem Patch & Plug Combos, 1 litre Can of Liquid Rubber Buffer Cleaner, 250ml Can of Fast Dry Vulcanising Solution, a Stitch Roller, 2 in 1 Hand Rasp & Cement Tool and a Rubber Scraper.



SAVE OVER 25%



Hopson String Repair Kit

The Hopson String Repair Kit includes a high quality Hand Rasp and Cement Tool, Insert Tool, Thick Brown Repair String and Vulcanising Solution.

TBDRK290

ONLY £6.99



Premium String Repair Kit

The Premium String Repair Kit includes a top quality T-handle Hand Rasp with Replacement Needle, T-handle Insert Tool with Replacement Needle, Thick Brown Repair String, Tyre Lube and Allen Keys.

TBDTRK

ONLY £9.99



Car Valeting & Personal Protection

Disposable Gloves



Latex Gloves

TBD08A	Medium Latex
TBD08B	Large Latex
TBD08C	Extra Large Latex

1 Box	10 Boxes	800 Boxes
£4.99	£4.30	£3.70
£4.99	£4.30	£3.70
£4.99	£4.30	£3.70



Blue Nitrile Gloves

TBD08DM-B	Medium Nitrile
TBD08DL-B	Large Nitrile
TBD08DXL-B	Extra Large Nitrile

1 Box	10 Boxes	800 Boxes
£4.99	£4.30	£3.70
£4.99	£4.30	£3.70
£4.99	£4.30	£3.70



Black Thick Nitrile Gloves

TBD08DM-N	Medium Nitrile
TBD08DL-	Large Nitrile
TBD08DXL	Extra Large Nitrile

1 Box	10 Boxes	800 Boxes
£5.49	£4.80	£4.13
£5.49	£4.80	£4.13
£5.49	£4.80	£4.13

Mix & Match Your Favourite When Buying 800 Boxes!

100 gloves per box

Personal Protection



TBD08E

Black Nitrile Coated Glove (1 Pair)

£1.99



TBD08F

Foam Nitrile Coated Glove (1 Pair)

£1.50



TBD09A

Beaded Hand Cleaning Gel 5kg

£8.49



TBD09L

Reusable Pump for 5kg Cleaning Gel

£6.95



TBD09B

Universal Barrier & Conditioning Cream 1 Litre

£2.40



TBD011HW

Heavy Duty Hand Wipes x 100

£7.99



TBD012HW

Heavy Duty Hand Wipes x 300

£18.95

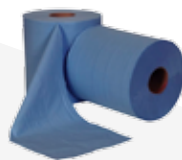

TBDCS05

Blue Roll x 6

£19.99



TBD089

Fluorescent Safety Jacket

£4.99



TBD088

Clear Safety Glasses

£2.99

Car Valeting



TBD092

Disposable Paper Floor Mats x 200

£11.98



TBD093

Disposable Car Seat Covers x 100

£11.98



TBD097

Wraparound Steering Wheel Covers x 10 Rolls

£32.99



TBD095

Elasticated Steering Wheel Covers x 250

£37.99



TBDALC

Aluminium Cleaner 5 Litre

£15.99



TBDPCOL

Car Polish 5 Litre

£28.99



TBDGLPOL

Car Glass Polish 5 Litre

£25.99



TBDSHAM

Car Shampoo 5 Litre

£12.49



TBDSILSP

Silicone Spray 400ml

£2.99



TBDVTE

Vinyl, Tyre & Engine Dressing 5 Litre

£22.99





Tyre Mounting Accessories

A range of accessories used to make the mount and demount process quick and easy without damaging the tyre.

Tyre Mounting

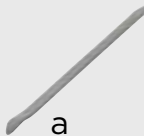
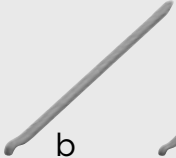
					
TBD001	TBD002A	TBD002D	TBD002B	TBD002C-4	TBD017-4
Mounting Paste Brush	White Tyre Mounting Paste (5kg)	Black Tyre Mounting Paste (5kg)	Tyre Mounting Wax (5kg)	Liquid Tyre Lube (5 litres)	Rim-Seal (5kg)
£2.49	£4.99	£5.99	£4.99	£4.94	£17.89

Tyre Levers

					
a	b	c	d	e	
a	b	c	d	e	
TBD012A	TBD012H	TBD012C	TBD012G	TBD012F	
Tyre Lever 12"	Tyre Lever 16"	Tyre Lever 24"	Tyre Lever 28"	Tyre Lever 41"	
£2.99	£5.99	£9.99	£14.99	£37.99	

Tyre Lever Pack **ONLY £22.99** **SAVE OVER 30%** **TBDLEVERPACK** Set of 4 Tyre Levers 12", 16", 24" and 28"

Tyre Mounting Aids

			
TBD028-2	HAWPRO	TBD026A-2	TBD026-2
Tyre Lever Protector Sleeve for Alloy Wheels	Plastic Alloy Wheel Protector Clip	3rd Hand Bead Depressor	Bead Wedge
£5.76	£4.39	£21.99	£27.49

Essential Pack of Consumables

Includes:

- 10g, 15g, 20g, 25g Knock-on Weights for Steel Wheels (100 of each)
- 10g, 15g, 20g, 25g Knock-on Weights for Alloy Wheels (100 of each)
- Self Adhesive Weights in 5g Sections x 50 strips,
- TR414 38mm Tubeless Tyre Valves x 100,
- TR418 49mm Tubeless Tyre Valves x 100,
- 6mm Repair Patch and Plug Combo x 24,
- Plastic Handled Valve Core Removal Key,
- 35mm Universal Repair Patches x 80,
- Fast Dry Vulcanising Solution 250ml,
- Liquid Rubber Buffing Solution 1 litre,
- White Tyre Mounting Paste 5kg,
- Plastic Screw-on Tyre Valve Mounter,
- Valve Knife with Tapered Blade,
- Bead Sealer with Brush 950ml,
- Medium Blue Nitrile Gloves,
- White Tyre Marking Chalk,
- Repair String Insert Tool,
- Spiral Cement Tool,
- Leakfinder 1 litre,
- Rubber Scraper,
- Stitch Roller,
- Paste Brush



TBDESSENTIALSTART

ONLY £179.00

Workshop Tools & Accessories

Essential workshop tools and accessories for any tyre bay.

Tyre Bath

This large tyre bath is an ideal alternative to the tyre testing tank. Measuring 838mm wide and 610mm deep this tub will cater to a wide range of tyres.



TBD11
ONLY £79.00

Tyre Testing Tank

The tyre testing tank has internal measurements of 285mm wide, 310mm deep, 760mm in length and is available in 3 variations.



TBD15	Tyre Testing Tank with Stand (pictured)	£206.00
TBD15SW	Tyre Testing Tank with Stand & Wheels	£215.00
TBD15WS	Tyre Testing Tank with Stand, Wheels & Spindle	£220.00

Wall Charts

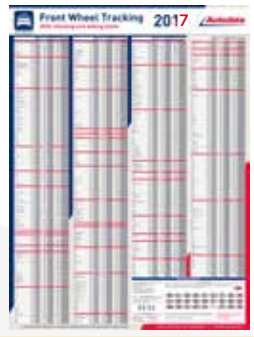

TBD10-3400

Front Wheel Tracking Chart

£34.99

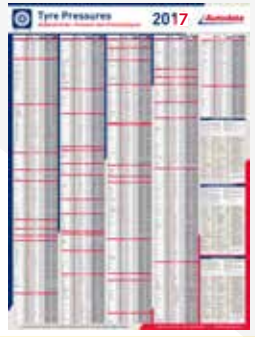

TBD10-3300

Tyre Pressure & Wheel Nut Torque Chart

£39.99



10-340-2P

Front Wheel Tracking, Tyre Pressure & Wheel Nut Torque Chart Pack

£56.00

Torque Wrenches



TBD3001A

1/2" Drive Ratchet Torque Wrench

£34.99



TBD3005A

3/4" Drive Ratchet Torque Wrench

£107.99

Bead Blaster

ONLY £99.99

TBD014FH

The Unite Bead Blaster has turned one of the most frustrating and time consuming jobs in the tyre shop into one of the quickest and easiest. It seats the beads of difficult tubeless tyres instantly by directing a rush of air into the gap between the tyre and rim, lifting the bead to give a contact seal which allows the tyre to inflate. This version has a 20 litre tank which is perfect for any workshop fitting tyres. (See page 11 for larger commercial bead blaster). Made in the UK and supplied with full CE certification.



Commercial Consumables & Tools

A range of consumables and tools specifically for commercial vehicles.

Knock-on Weights for Commercial Vehicles



Item No.	Weight	Price
TBD50TW	50g	£3.67
TBD75TW	75g	£5.05
TBD100TW	100g	£6.44
TBD150TW	150g	£9.20
TBD200TW	200g	£11.94
TBD250TW	250g	£14.82
TBD300TW	300g	£17.65
TBD350TW	350g	£20.43
TBD400TW	400g	£23.24

Balancing Compound

Can you afford not to be balanced?

New test with **EASY BALANCE** shows savings of up to 33% in tyre cost per km!

Easy and fast application during tyre fitting. One balancing for the whole tyre's lifetime, with better precision than lead-weight balancing. Tyre wear is minimised, as is wear on suspension, chassis and wheel bearings.



A heavy duty, multi purpose tyre sealant offering an effective method of puncture repair for use with both on-road and off-road tyres.

Slowly pump the required amount into the tyre to prevent punctures to commercial and agricultural tyres.

Also available in smaller pouches.



TBDBP7.5KG

EASY BALANCE Balancing Compound 7.5kg Tub

£139.99

TBDTYS20

Heavy Duty Multi Purpose Tyre Sealant 20 Litres

£69.99

Commercial Tyre Valves & Connectors



TR570C

90 Degree Metal Tubeless Tyre Valve for 16mm Rim Holes x10

£8.39



V3.12.1

European Style Low Profile Tyre Valve for 16mm Rim Holes x10

£12.97



V3.20.4

27 Degree European Style O-Ring Seal for 9.7mm Rim Holes x10

£8.48



V3.20.1

Straight European Style O-Ring Seal for 9.7mm Rim Holes x10

£7.74



TR543D

60 Degree O-Ring Seal for 9.7mm Rim Holes x10

£8.15



CO2F03

Euro Clip with 4.75mm (3/16") Tailpiece (Closed End)

£7.65 EACH

Wheel Nut Safety

Rollock Wheel Nut Clamps are an inexpensive way to guarantee wheel nut security. Each clamp locks two nuts and is very easy to fit. All you need is our easy to use tool and a plastic-faced hammer. This Complete Starter Kit includes 150 Rollock Clamps, Application Tool, Removal Tool and a Deadblow Hammer.



RSTARTKIT ONLY £189.99

Visit our website for more information.

Checkpoint wheel nut indicators are designed to provide a clear visual indication of wheel nut movement. Available in a wide range of sizes. Sold in packs of 100.



ONLY £29.99

Visit www.tyrebaydirect.com for full range of sizes.

Commercial Tools

Bead breaker with heavy duty, strengthened construction for a longer life. Overall length: Closed: 37" Open: 61"



TBDBK

Double Handled Bead Knocker

£199.99

37 litre tank designed to give a quick and powerful blast of air to instantly seat commercial tyres.



TBD014C

Commercial Bead Blaster

£185.99

Air Tools & Accessories

Affordable, high quality impact wrenches and accessories.

Impact Wrenches



TBD2508K

1/2" Drive Impact Wrench Kit

£44.99



TBD2800

1/2" Drive Impact Wrench

£49.99



TBD2140

1/2" Drive High Torque Impact Wrench

£76.99



TBD5301S

1" Drive Impact Wrench

£199.99

Item No.	TBD2508K	TBD2800	TBD2140	TBD5301S
Torque ft Lbs (Nm)	313	550	680	2600
Free Speed (r.p.m)	7000	7500	7000	4000
Weight (kg)	2.2	2.5	2.0	12

Air Tools



TBD10A

Reversible Air Drill with 10mm Keyless Chuck

£55.99



TBD1004K

1/2" Drive Air Ratchet Wrench Kit

£29.99



TBD5001

Air Hammer Kit

£34.99



TBD084-4

Air Tool Oil 1 Litre

£4.99

Sockets



TBDAWNSS/3

1/2" Drive Insulated 17mm, 19mm, 21mm Socket Set

£19.99



TBDATA33

1/2" Square Drive Insulated 10 Piece Deep Impact Socket Set

£29.99



TBDATA32

1/2" Drive 14 Piece Socket Set

£34.99



TBDLWNS4

4 Piece Locking Wheel Nut Removal Set

£27.99

Locking Wheel Nuts



TBDB1

Locking Wheel Nuts for Peugeot 12mm x 1.25 Male x4

£4.49



TBDB2

Locking Wheel Nuts for Vauxhall/Volkswagen 12mm x 1.5 Male x4

£4.49

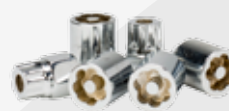

TBDD3

Locking Wheel Nuts for Volkswagen/Rover/Ford 12mm x 1.5 Female x4

£4.49



TBDD4

Locking Wheel Nuts for Subaru/Nissan 12mm x 1.25 Female x4

£4.49

Value Kit of Locking Wheel Nuts



ONLY £14.99

TBDVALUEKIT

Peugeot 12mm x 1.25 Male x4
Vauxhall/Volkswagen 12mm x 1.5 Male x4
Subaru/Nissan 12mm x 1.5 Female x4
Volkswagen/Rover/Ford 12mm x 1.25 Female x4

**SAVE
OVER
16%**

**STAR
BUY**



Inflation Gauges

AFG4H04	ALG3H061	AFG4H03	AFG4H05	AFG4H06	DAC1A08
PCL MK4 Gauge with Single Clip-on Connector & 0.53m (21") Hose	PCL MK3 Gauge with Single Clip-on Connector & 2.7m (9ft) Hose	PCL MK4 Gauge with Twin Hold-on Connector & 0.53m (21") Hose	PCL MK4 Gauge with Twin Clip-on Connector & 1.8m (6ft) Hose	PCL MK4 Gauge with Twin Clip-on Connector & 2.7m (9ft) Hose	PCL Accura Digital Gauge with Single Clip-on Connector & 1.8m (6ft) Hose in PSI
£47.99	£59.99	£47.69	£58.99	£59.99	£59.99

Gauges

TBD008	TDG16C01	DTPG7
Tyre Pressure Pencil Gauge	MOT Approved Tread Depth Gauge	2in1 Digital Pressure & Tread Depth Gauge
£1.99	£2.99	£28.50

Connectors

RHA2122	CODC54	CO1A03	CO3A03	CO3B03
Twin Hold-on Connector (Closed End) & 21" Hose	Twin Hold-on Connector (Closed End)	Twin Hold-on Connector (Open End)	Twin Clip-on Connector (Open End)	Twin Clip-on Connector (Closed End)
£19.95	£2.49	£6.99	£22.79	£23.70

Air Line with Standard Adapter & Vertex Coupling



HA2133	5m Air Line 10mm ID x 17mm OD	£14.99
HA2125	10m Air Line 8mm ID x 15mm OD	£21.99
HA2134	10m Air Line 10mm ID x 17mm OD	£19.99
HA2152	30m Air Line with PCL 100 Series Fittings 13mm ID x 21mm OD	£69.99

Air Lines



HA2016	10m Air Line with 1/4" Female Swivel Ends 7mm ID x 14mm OD	£17.99
HA2018	10m Air Line with 3/8" Female Swivel Ends 10mm ID x 17mm OD	£22.99
HA2046	20m Air Line with 1/4" Female Swivel Ends 10mm ID x 17mm OD	£29.63

Retractable Air Lines



HR816	12m Air Line Reel - 1/4" Male Adaptor 8mm ID	£79.99
HRA1B03	15m Economy Air Line Reel - 1/4" Adaptor 10mm ID	£87.99
HRA3J01	15m Heavy Duty Air Line Reel - 1/2" Adaptor 12mm ID	£159.99

73 Piece Air Tool Kit

Includes:

- **1/2" Impact Wrench:**
 - 7000.0rpm, 230ft/lbs torque
 - 8x 1/2" sockets (9/16", 7/16", 5/8", 1/2")
 - 3" drive extension
- **3/8" Reversible Ratchet:**
 - 160.0rpm, 50ft/lbs (68Nm) torque
 - 3/8" to 1/2" drive socket adaptor
 - 4x 3/8" sockets (8mm, 9mm, 5/16", 3/8")
 - 3/8" screwdriver & 10 bits
- **Air Die Grinder:**
 - 22,000rpm & 10 grinding stones
 - 3/8" collet, 1" & 3/4" sanding drums
 - 10x sanding sleeves, 2x wrenches
- **150mm Air Hammer:**
 - 4500 blows per/min
 - 4x 125mm chisel, retaining spring

- **Air Blow Gun**
 - 5x nozzles
 - tyre pressure gauge
 - 4x 1/4" bayonets (male, Euro),
 - 1/4" air line coupler
 - Jubilee clip
 - Oil bottle
 - Hex key
 - PTFE tape

TBDSIP73
ONLY
£137.99

73 PIECE KIT!



Car Wheel Dollies

SIP Wheel Dollies are constructed from pressed steel, capable of holding 450kg despite their compact size, plus heavy duty castors allow easy movement of the load. Supplied in pairs.

- 450.0kg capacity per dolly
- Lightweight - just 18.0kg (pair)
- 4 heavy-duty swivel castors
- Pressed steel construction
- Supplied in pairs



TBDSIP3833

Car Wheel Dolly (Pair)

£75.99

Drum Fans

- 20.0" fan diameter
- 230v (13amp) supply
- Powerful 111.0W motor
- 3-speed (850/1100/1350rpm)
- Lightweight - weighs 6.5kg!
- Keeps air circulating and fresh
- Aids ventilation of odours and fumes
- Can also be used for drying purposes



TBDSIP5613

20" Drum Fan

£75.99

- 36.0" fan diameter
- 230v (13amp) supply
- Powerful 378.0W motor
- 2-speed (1375/1425rpm)
- Lightweight - weighs 26.0kg!
- Keeps air circulating and fresh
- Aids ventilation of odours and fumes
- Can also be used for drying purposes



TBDSIP5622

36" Drum Fan

£199.99

Slimline Swivel SMD Inspection Lamp

This Slimline Swivel Inspection Lamp is fitted with a long lasting Lithium-Ion battery and a base magnet and hook for positioning on work surfaces. Main light and spotlight for different uses.

- 10+1 extreme white light SMDs:
 - 500 Lux / 300 Lumen (main light)
 - 800 Lux / 050 Lumen (top/spotlight)
- Reliable, durable Lithium-Ion battery
- Super long 15hr torch, 5hr main light (continual)
- Multi-functional 180° forward and backward tilt
- Strong integral base magnet for positioning
- Mains and USB charge port for recharging
- Integrated hanging hook - 360° rotation
- Battery test button
- Soft-feel finish



TBDSIP6445

Slimline Swivel SMD Inspection Lamp

£37.99

30 Meter Air Hose Reel

- 30m metre hose length with 9.5mm hose diameter
- 2 metre connection hose length
- 145.0psi (10.0 bar) working pressure
- High-visibility yellow PVC hose
- -5°C to 45°C working temperature range
- Through flow - air passes through centre of the reel so it can be wound/unwound during operation
- Auto Layer technology
 - automatically layers hose across the reel preventing bunching in the case
- Quality ratchet and recoil system
- Pivot wall mounting bracket
- 1/4" BSP male air inlet
- Strong plastic casing
- Carry handle



TBDSIP7976

30 Meter Air Hose Reel

£149.99

Tyres & Racking

We supply a huge range of budget, midrange and premium tyres all at highly competitive prices! Tyres will be delivered on the next working day FREE of charge to a mainland UK business address with no minimum spend required unless otherwise informed. For an instant tyre quote and to see how much you could save please visit our website or call our sales team with the sizes you require.

PACK OF 24 BUDGET TYRES



TYRES INCLUDED IN THE PACK

WIDTH	PROFILE	RIM	SPEED	QTY
205	55	16	W	4
195	65	15	H	4
225	45	17	W	2
225	40	18	W	2
175	65	14	H	4
195	60	15	V	2
185	65	15	H	2
185	65	14	H	2
215	55	16	V	2

The ready-made Pack of 24 Budget Tyres is made up of 9 of the most popular sizes in a range of brands and will be delivered straight to your door. Call us now for today's best price.

Tyre Racking

With its tubular beams this tyre racking provides the perfect support for car tyres allowing them to be stored safely and efficiently. Can't find a suitable size for your garage? Contact us today with your measurements for a bespoke solution.

Stand Alone Racking

ASS395

W 1.2m x D 0.4m x H 2m
3 Tyre Storage Levels
Estimated Tyre Capacity: 18

£140.00

ASS396

W 1.2m x D 0.4m x H 2.5m
4 Tyre Storage Levels
Estimated Tyre Capacity: 24

£186.00

ASS397

W 1.2m x D 0.4m x H 3m
5 Tyre Storage Levels
Estimated Tyre Capacity: 30

£234.00

Racking Extension (requires existing racking)

ASE398

W 1.2m x D 0.4m x H 2m
3 Tyre Storage Levels
Estimated Tyre Capacity: 18

£103.00

ASE399

W 1.2m x D 0.4m x H 2.5m
4 Tyre Storage Levels
Estimated Tyre Capacity: 24

£155.00

ASE400

W 1.2m x D 0.4m x H 3m
5 Tyre Storage Levels
Estimated Tyre Capacity: 30

£175.00

This simple to install tyre storage is assembled without any nuts or bolts and requires no special tools, only a mallet!

TBDRM750FG



32oz Rubber Mallet

£7.50





Redback Garage Equipment



Why choose Redback Garage Equipment?

Redback is Tyre Bay Direct's own brand of garage equipment. The range offers superior, entry level equipment designed for tyre shops looking for a good piece of kit whilst staying within a limited budget. The Redback models are the result of over a decade of experience in tyre equipment development. Sourced from the best manufacturers Redback Garage Equipment from Tyre Bay Direct provides exceptional equipment at affordable prices. Unsure which model would be best for you? Give our helpful team a call today.

Redback 700 28" Turntable-Less & Lever-Less Tyre Changer with Assist Arm

- Turntable-less adjustable centre system equipped with universal adaptor
- Reliable pedal control and two speed options (6/12 rpm) for improved efficiency
- 4th Generation patented assist arm with increased strength and smoothness
- New patented lever-less head with increased durability and accuracy of angle
- Ergonomic design for mounting low profile and run flat tyres

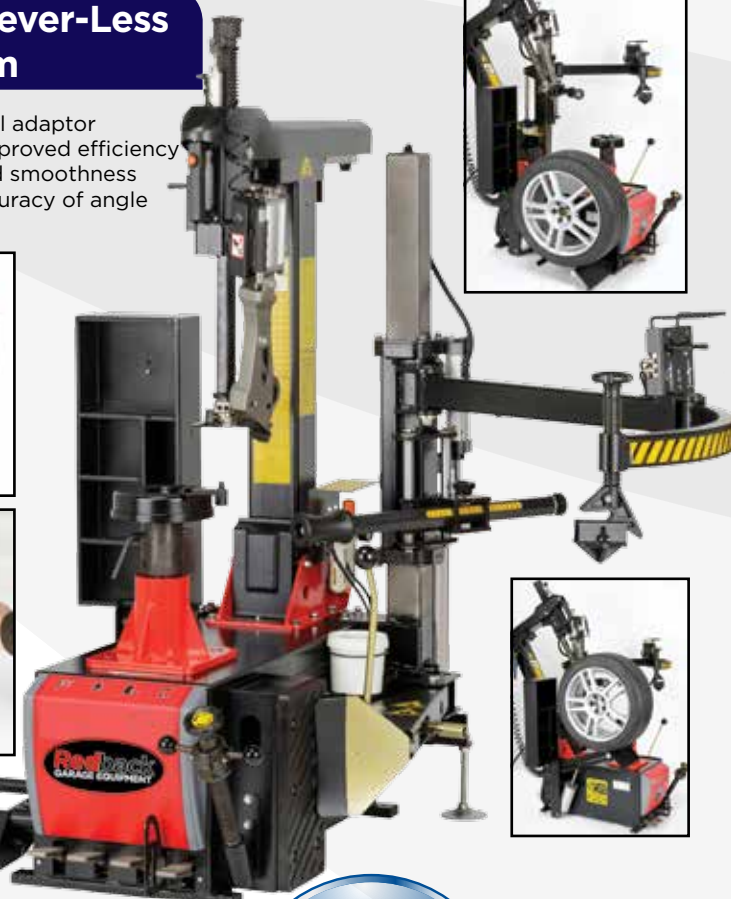
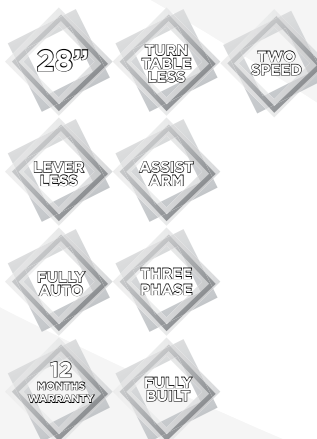

TBDRB700

ONLY £2,999

or £17.30 a week

Redback 900 30" Magnetic Levitation Wheel Balancer with Laser

- Self propelled magnetic levitation system (no motor or belt)
- Automatic data input of offset, wheel width and diameter
- VDL monitor with animated balancing program
- Visual laser technology which projects a laser cross onto the rim for precise weight placement
- High precision angular position program
- Advanced spin brake

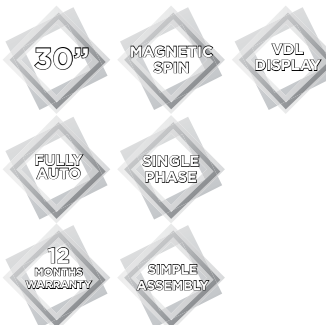

BUY AS A PACKAGE FOR ONLY £4,699



TBDRB900

ONLY £1,999

or £11.53 a week

Redback 200 22" Semi Automatic Tyre Changer

- Semi automatic tyre machine capable of changing tyres on up to 22" wheels
- Suitable for passenger and light commercial wheels
- Swing arm for minimal working space making it ideal for small workshops and mobile tyre fitting vans
- **Option to add assist arm**
- Capable of changing motorcycle tyres with additional adaptors

- 22"
- SEMI AUTO
- SINGLE PHASE
- 12 MONTHS WARRANTY
- SIMPLE ASSEMBLY



TBDRB200
ONLY
£749

Redback 221 24" Fully Automatic Tyre Changer

- Fully automatic tyre machine capable of changing tyres on up to 24" wheels
- Suitable for passenger and light commercial wheels
- Pneumatically controlled rear tilting column
- Variable speed turntable between 0-12rpm
- Easily adjustable bread breaker positioning with 2 level adjustments
- Easy one-finger push / pull positioning of horizontal slide arm

- 24"
- FULLY AUTO
- SINGLE PHASE
- VARIED SPEED
- 12 MONTHS WARRANTY
- FULLY BUILT



TBDRB221
ONLY
£1,599
or £9.23 a week

Redback 226 24" Fully Automatic Tyre Changer with Assist Arm

- Fully automatic tyre machine for up to 24" wheels
- Assist arm for run flat and low profile tyres
- Easy one-finger push / pull positioning of horizontal slide arm
- Variable speed turntable (0-12rpm)
- Easily adjustable bread breaker positioning with 2 level adjustments

- 24"
- ASSIST ARM
- VARIED SPEED
- FULLY AUTO
- 12 MONTHS WARRANTY
- SINGLE PHASE
- FULLY BUILT



TBDRB226
ONLY
£1,899
or £10.96 a week

Redback 665 26" Fully Automatic Tyre Changer with Double Assist Arms

- Fully automatic tyre machine capable of changing tyres on up to 26" wheels
- Suitable for passenger and light commercial wheels
- Built in bead blaster tank to seat tyres
- Pneumatically controlled column
- Double assist arms for run flat and low profile tyres

- 26"
- TWO ASSIST ARMS
- BEAD BLASTER
- FULLY AUTO
- 12 MONTHS WARRANTY
- SINGLE PHASE
- FULLY BUILT



TBDRB665
ONLY
£2,199
or £12.69 a week

Redback Commercial Equipment

Redback 290 26" Commercial Tyre Changer

- Fully automatic commercial tyre machine capable of changing tyres on up to 26" wheels
- Suitable for fitting truck and bus tyres
- Tyre sliding platform for easy positioning
- Electro hydraulic driven
- Supplied in single phase or three phase

Redback 850 24" Commercial Wheel Balancer

- Commercial wheel balancer capable of balancing up to 24" wheels
- Manual data input of offset and wheel diameter
- Suitable for balancing car, truck and bus wheels
- Pneumatic commercial tyre lifting platform
- Brake pedal for wheel weight placement accuracy

26"

FULLY AUTO

SINGLE OR THREE PHASE

12 MONTHS WARRANTY

SIMPLE ASSEMBLY

24"

MANUAL

SINGLE OR THREE PHASE

12 MONTHS WARRANTY

SIMPLE ASSEMBLY

BUY AS A PACKAGE FOR ONLY £4,999



TBDRB290

ONLY £3,499
or £20.19 a week



TBDRB850

ONLY £1,699
or £9.80 a week

Adaptors For Redback Garage Equipment

Tyre Changer Adaptors

Set of 4 adaptors to attach to the clamping jaws for the mounting & demounting of motorcycle tyres.

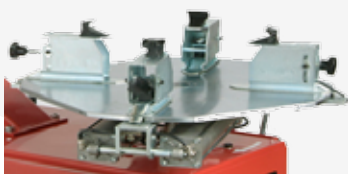

TBDEA25

Motorcycle Clamping Jaw Adaptor for Redback Tyre Changer

£149.00

Metal mounting head for the mounting & demounting of motorcycle tyres.



TBDEA03M

Motorcycle Mounting Head Redback Tyre Changer

£43.20

Wheel Balancer Adaptors



TBDEA23

Motorcycle Adaptor for Redback Wheel Balancer

£199.00



TBDEA10A

Centre-Less Adaptor for Redback Wheel Balancer

£199.00



TBDEA13

Quick Release Locking Wing Nut for Redback Wheel Balancer

£62.00



TBDEA03

Light Commercial Kit for Redback Wheel Balancer

£149.00



TBDEA16A

Set of 3 Cones for Redback Wheel Balancer

£149.00

Redback 109 24" Hand Spin Wheel Balancer

- Requires manual data input of offset, wheel width and rim diameter
- Hand spin model suitable for passenger vehicle wheels
- Can balance motorcycle wheels with an additional adaptor
- Capable of balancing up to 24" wheels
- Brake pedal for accurate wheel weight placement
- Compact design ideal for small workshops and vans

24" HAND SPIN
 MANUAL SINGLE PHASE
 SIMPLE ASSEMBLY 12 MONTHS WARRANTY



TBDRB109
ONLY £549

Redback 800 24" Motorised Wheel Balancer

- Requires manual data input of offset, wheel width and rim diameter
- Motorised spin model suitable for passenger vehicle wheels
- Capable of balancing up to 24" wheels
- Ideal for small to medium workshops with limited space

24" MOTOR SPIN MANUAL
 SINGLE PHASE SIMPLE ASSEMBLY 12 MONTHS WARRANTY



TBDRB800
ONLY £749

Redback 830 30" Semi Automatic Magnetic Wheel Balancer

- Semi automatic wheel balancer capable of balancing most rims on the market
- Bright LED Display
- Built in cone and accessory storage
- Easy function key pad
- Magnetic levitation module
- High precision weight positioning
- Smart Position Locator
- Advanced Spin Brake
- Linear Optical Encoder

30" MAGNETIC SPIN SEMI AUTO
 SINGLE PHASE SIMPLE ASSEMBLY 12 MONTHS WARRANTY



TBDRB830
ONLY £999
 or £5.76 a week

Redback 840 24" LCD Fully Automatic Wheel Balancer

- Motorised wheel balancer capable of balancing up to 24" wheels
- Automatic data input of offset, wheel diameter and wheel width
- LED light for weight placement
- Suitable for passenger vehicle wheels

24" FULLY AUTO MOTOR SPIN
 SINGLE PHASE SIMPLE ASSEMBLY 12 MONTHS WARRANTY



TBDRB840
ONLY £1,199
 or £6.92 a week

Redback Packages

Complete Starter Package

The Complete Starter Package includes everything you need to get your tyre bay started. We have selected a range of our most popular models that go hand in hand together and will keep you in good stead for years to come.

Includes:

- Redback 226 24" Fully Automatic Tyre Changer with Assist Arm
- Redback 820 24" Semi Automatic Wheel Balancer
- SIP 150 Litre Air Compressor
- Winntec 3 Ton Floor Jack x2
- Fore 1/2" Drive Impact Wrench Kit
- Draper 1/2" Drive Ratchet Torque Wrench
- PCL 5 Metre Airline with Adaptors x2
- Large pack of tyre consumables

ONLY
£3,499
or **£20.19**
a week



Mobile Starter Package

The Mobile Starter Package includes all the equipment you need to start a mobile tyre fitting business. With the installation included you can simply drop off your van, we'll work our magic and you'll be on the road in no time!

Includes:

- Redback 226 24" Fully Automatic Tyre Changer with Assist Arm
- Redback 109 24" Hand Spin Wheel Balancer
- Engine AIR 100 Litre Petrol Compressor
- Winntec 3 Ton Floor Jack
- Fore 1/2" Drive Impact Wrench Kit
- Draper 1/2" Drive Ratchet Torque Wrench
- PCL 5 Metre Airline with Adaptors x2
- Large pack of tyre consumables
- Set of 4 Anti Vibration Plates
- Inverter
- Split Charger
- Industrial Battery

Installation
Included!



*Van not included



ONLY £4,999
or **£28.84** a week

Contact us for a delivery only quote (not installed)

Redback Packages

Mix and match any Redback tyre changer and wheel balancer to create your perfect package.

Entry Level Package

Includes:

- Redback 200 22" Semi Automatic Tyre Changer
- Redback 109 24" Hand Spin Wheel Balancer

Add Assist Arm
for an extra
£100



ONLY £1,149
or £6.63 a week

Semi Automatic Package

Includes:

- Redback 221 24" Fully Automatic Tyre Changer
- Redback 800 24" Motorised Wheel Balancer
- Essential pack of consumables



ONLY £2,149
or £11.53 a week

Run Flat Capable Package

Includes:

- Redback 226 24" Fully Automatic Tyre Changer with Assist Arm & Bead Blaster
- Redback 830 24" Semi Automatic Wheel Balancer
- Essential pack of consumables



ONLY £2,749
or £14.99 a week

Premium Package

Includes:

- Redback 665 26" Fully Automatic Tyre Changer with Double Assist Arms & Bead Blaster
- Redback 840 24" Fully Automatic Wheel Balancer
- Essential pack of consumables



ONLY £3,149
or £17.30 a week

Cormach Tyre Changers

Tyre Bay Direct are proud to offer top end Italian tyre service equipment from exceptional manufacturers, Cormach. Read more about what is included with all Cormach equipment from Tyre Bay Direct on page 25.



Cormach CM 646 GT 26" Fully Automatic Tyre Changer

- Fully automatic tyre changer for cars and light commercial vehicles
- Quick manual adjustment lever for clamping lock between 24" to 26"
- Pneumatic tilting column by pedal control
- Variable rotation speed (8-13 rpm) by pedal control
- Option to add built in bead blaster tank to quickly seat tyres - see details below
- Option to add 3 way assist arm for low profile and run flat tyres - see details below

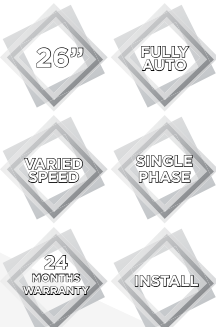

CM646 ONLY
£3,999
 or £23.07 a week

Cormach LIGRO GT 26" Lever-Less Fully Automatic Tyre Changer

- Fully automatic tyre changer with 'no-lever' technology
- Quick manual adjustment lever for clamping lock between 24" to 26"
- Pneumatic tilting column by pedal control
- 2 rotation speeds (6/12 rpm) by pedal control
- Option to add built in bead blaster tank to quickly seat tyres - see details below
- Option to add 3 way assist arm for low profile and run flat tyres - see details below

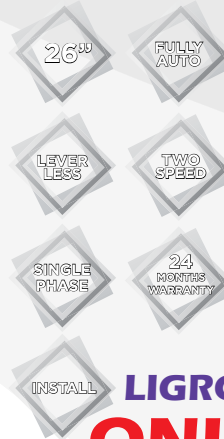

LIGRO ONLY
£4,680
 or £27.00 a week

Cormach PUMA 30" Super Automatic Lever-Less Tyre Changer

- Super automatic tyre changer for low profile and run flat tyres
- Variable rotation speed by pedal control (between 7-18 rpm)
- Pneumatic device for wheel lifting by pedal control
- Automatic side-swinging tool head arm and pneumatic controls
- Inflator device by pedal control
- Suitable for rims up to 30"
- Pneumatic 'no-lever' technology equipped with plastic protections



PUMA ONLY
£7,499
 or £43.26 a week

Optional Extras

Assist Arm & Bead Seater



Easily change run flat and low profile tyres with the optional assist arm designed specifically for the CORMACH CM 646 and LIGRO models.

Visit our website for more info

Quickly seat loose tyre beads with the optional built in bead blaster suitable for the CORMACH CM 646 and LIGRO models.



Cormach MEC 20 35" Fully Automatic Wheel Balancer

- Fully automatic wheel balancer capable of balancing up to 35" wheels
- Automatic acquisition of wheel distance, width and diameter data through accelerometer
- Electromagnetic brake with automatic search of the unbalance position
- LED lighting for inner gauge positioning and weight application
- Suitable for motorbike wheels with additional adaptor

- 35"
- MOTOR SPIN
- FULLY AUTO
- SINGLE PHASE
- 24 MONTHS WARRANTY
- INSTALL



MEC-20
ONLY £2,649
 or £15.38 a week

Cormach MEC-820-VDL 35" Fully Automatic Wheel Balancer w/ Monitor

- Fully automatic wheel balancer capable of balancing up to 35" wheels
- Automatic acquisition of wheel distance, width and diameter with all data shown on VDL monitor
- Electromagnetic brake with automatic search of the unbalance position
 - Innovative sensor gauge for diameter and distance data entry
 - Suitable for motorbike wheels with additional adaptor

- 35"
- MOTOR SPIN
- FULLY AUTO
- VDL DISPLAY
- SINGLE PHASE
- 24 MONTHS WARRANTY
- INSTALL



MEC-820-VDL
ONLY £3,249
 or £18.74 a week

Cormach TOUCH MEC 35" Fully Automatic Wheel Balancer w/ Touch Screen

- Fully automatic wheel balancer capable of balancing up to 35" wheels
- 21" heavy duty touch screen for intense and stressed use which can also be used with gloves
- Automatic acquisition of wheel distance, width and diameter data through accelerometer
- Innovative sensor gauge for diameter and distance data entry that automatically starts ALU SPECIAL balancing program without using the keyboard
- Electromagnetic brake with automatic search of the unbalance position
- Suitable for motorbike wheels with additional adaptor
- Space-saving wheel guard

- 35"
- MOTOR SPIN
- TOUCH SCREEN
- FULLY AUTO
- INSTALL
- SINGLE PHASE
- 24 MONTHS WARRANTY



TOUCH-MEC
ONLY £4,999
 or £28.84 a week

Cormach Wheel Balancer Standard Accessories

Standard accessories included with all CORMACH Wheel Balancers from Tyre Bay Direct.

- Accessories included**
- Quick Release Locking Wing Nut
 - Wing Nut Adaptor
 - Set of 4 Cones
 - Sensor Gauge & Support
 - Universal Weight Pliers
 - Threaded Shaft

Cormach Automatic Package

The **Cormach Automatic Package** includes the CM 646 tyre changer with a large 26" turntable and the MEC 20 capable of balancing up to an impressive 35". With a 2 year warranty and the impeccable Cormach reputation you can rest assured that this Italian equipment will be of the utmost quality.

Includes:

- Cormach CM 646 26" Fully Automatic Tyre Changer
- Cormach MEC 20 35" Fully Automatic Wheel Balancer

26"

VARIED SPEED

FULLY AUTO

SINGLE PHASE

24 MONTHS WARRANTY

INSTALL



35"

MOTOR SPIN

FULLY AUTO

SINGLE PHASE

24 MONTHS WARRANTY

INSTALL

ONLY £6,299
or £36.34 a week

Cormach Fully Automatic Package

The **Cormach Fully Automatic Package** includes the LIGRO tyre changer with complete with lever-less mounting head, assist arm and built in bead blaster making tyre changing as simple and manual-free as possible. You'll also receive the MEC-820-VDL wheel balancer which offers fully automatic data input and a smart VDL monitor.

Includes:

- Cormach LIGRO 26" Fully Automatic Tyre Changer with
 - Lever-Less Mouting Head
 - 3 Way Assist Arm for run flat and low profile tyres
 - Built in Bead Blaster to quickly seat loose beads
- Cormach MEC-820-VDL 35" Fully Automatic Wheel Balancer with VDL Monitor



26"

LEVER LESS

FULLY AUTO

ASSIST ARM

TWO SPEED

SINGLE PHASE

BEAD BLASTER

INSTALL

24 MONTHS WARRANTY



35"

MOTOR SPIN

FULLY AUTO

LCD DISPLAY

SINGLE PHASE

24 MONTHS WARRANTY

INSTALL

ONLY £8,299
or £47.88 a week

Cormach Super Automatic Package

The **Cormach Super Automatic Package** includes the PUMA 30" Super Automatic Lever-Less Tyre Changer which features a lever-less mounting head and variable turntable speeds. Alongside the PUMA is the TOUCH-MEC, a 35" Fully Automatic Wheel Balancer complete with a touch screen monitor.

Includes:

- Cormach PUMA 30" Super Automatic Lever-Less Tyre Changer with
 - Lever-Less Mounting Head
 - Assist Arm for run flat and low profile tyres
 - Variable turntable speeds
- Cormach TOUCH-MEC 35" Fully Automatic Wheel Balancer with Monitor
 - Locking set for reverse rims



ONLY
£10,999
or £63.46
a week



THE CORMACH TOUCH

Included with all Cormach Machines from Tyre Bay Direct

- 2 Year parts and labour warranty
- Delivery, installation and demonstration
- Dedicated account manager
- Comprehensive service package available
- Discounted consumable prices
- Extended warranty options available

Plus **FREE** service in the first year!



Finance available - pay nothing for the first 3 months!*

*Finance subject to status.



CORMACH
CORREGGIO MACHINERY

we care

Tyre Bay Direct are proud to supply high quality, efficient and extremely reliable professional automotive equipment from manufacturer, Winntec. Made from the very best materials you get maximum value for your investment and will be backed by outstanding customer service and a 3 Year "No Nonsense" full manufacturer's warranty.

2 Ton 'Turbo Lift' Trolley Jack

- 2 ton lifting capacity
- 115mm - 450mm lifting height
- Universal joint release valve
- 'Turbo Lift' system
- Dual-pump pistons
- Chrome plated main ram
- Nylon wheels



TBD1104

2 Ton 'Turbo Lift' Trolley Jack

£149.99

2 Ton Low 'Turbo Lift' Trolley Jack

- 2 ton lifting capacity
- 75mm - 510mm lifting height
- Universal joint release valve
- 'Turbo Lift' system
- Dual-pump pistons
- Chrome plated main ram
- Nylon wheels



TBD1102

2 Ton Low 'Turbo Lift' Trolley Jack

£134.99

2 Ton Low Lift Lightweight Trolley Jack

- 2 ton lifting capacity
- 85mm - 490mm lifting height
- Lightweight low profile
- Fast reach foot pedal
- Universal joint release valve
- 'Turbo Lift' system
- Dual-pump pistons
- Chrome plated main ram
- PU Tandem wheels



TBD1104LP

2 Ton Lightweight Low Profile Trolley Jack

£299.99

3 Ton 'Turbo Lift' Trolley Jack (PU Wheels)

- 3 ton lifting capacity
- 120mm - 450mm lifting height
- 'Turbo Lift' system
- Heat treated chromed pump pistons
- Universal joint release valve
- Removable two piece handle with rubber grip
- Rubber saddle pad



TBD1101

3 Ton 'Turbo Lift' Trolley Jack (PU Wheels)

£129.99

3 Ton 'Turbo Lift' Trolley Jack (Steel Wheels)

- 3 ton lifting capacity
- 130mm - 490mm lifting height
- 'Turbo Lift' system
- Heat treated chromed pump pistons
- Universal joint release valve
- Removable two piece handle with rubber grip
- Rubber saddle pad



TBD1103

3 Ton 'Turbo Lift' Trolley Jack (Steel Wheels)

£169.99

2 Ton Pneumatic Balloon Jack

- 2 ton lifting capacity
- 115mm - 295mm lifting height
- Internal telescopic stabiliser provides lateral and vertical stability
- Easily positioned on vehicle lifts
- Safety valve to prevent over inflation

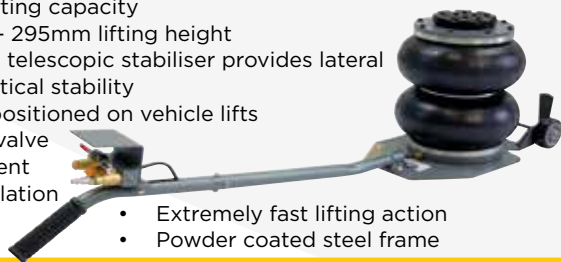

- Extremely fast lifting action
- Powder coated steel frame

TBD112TPB

2 Ton Pneumatic Balloon Jack

£399.99

1.35 Ton Aluminium Racing Jack

- 1.35 ton lifting capacity
- 80mm - 375mm lifting height
- All-Aluminium construction
- Weighs only 10kg
- Universal joint and single pump system for added reliability
- Side carry handles
- Rubber saddle pad
- Non-marking wheels



TBDARJ135

1.35 Ton Aluminium Racing Jack

£159.99

3 Ton Jack Stands

- 3 ton supporting capacity
- 322mm - 465mm lifting height
- Supplied in pairs
- Pin type support column adjusts to multiple heights
- Large support saddle with rubber protection to avoid damage to lifting point
- Total weight (as a pair) 5.2kg



TBD1100W

3 Ton Jack Stands

£47.99

6 Ton Jack Stands

- 6 ton supporting capacity
- 404mm - 604mm lifting height
- Supplied in pairs
- Pin type support column adjusts to multiple heights
- Large support saddle with rubber protection to avoid damage to lifting point
- Total weight (as a pair) 11.2kg



TBD2100W

6 Ton Jack Stands

£89.99

3 Year Warranty

6 Ton Bottle Jack

- 6 ton lifting capacity & 125mm lifting height
- European design tested to the latest European standards
- Twist top for precise height adjustments
- Can be used in horizontal and vertical positions
- Solid chromed pump linkage
- Overload protection
- Cast iron base



TBDBJW6T

6 Ton Bottle Jack

£34.99

12 Ton Bottle Jack

- 12 ton lifting capacity & 125mm lifting height
- European design tested to the latest European standards
- Twist top for precise height adjustments
- Can be used in horizontal and vertical positions
- Solid chromed pump linkage
- Overload protection
- Cast iron base



TBDBJW12T

12 Ton Bottle Jack

£69.99

20 Ton Bottle Jack

- 20 ton lifting capacity & 145mm lifting height
- European design tested to the latest European standards
- Twist top for precise height adjustments
- Can be used in horizontal and vertical positions
- Solid chromed pump linkage
- Overload protection
- Cast iron base



TBDBJW20T

20 Ton Bottle Jack

£69.99

30 Ton Bottle Jack

- 30 ton lifting capacity & 180mm lifting height
- European design tested to the latest European standards
- Twist top for precise height adjustments
- Can be used in horizontal and vertical positions
- Solid chromed pump linkage
- Overload protection
- Cast iron base



TBDBJW30T

30 Ton Bottle Jack

£99.99

20 Ton Low-level Bottle Jack

- 20 ton lifting capacity & 90mm lifting height
- European design tested to the latest European standards
- Twist top for precise height adjustments
- Can be used in horizontal and vertical positions
- Solid chromed pump linkage
- Overload protection
- Cast iron base



TBDBJLE20T

20 Ton Low-level Bottle Jack

£69.99

20 Ton Air Bottle Jack

- 20 ton lifting capacity & 245mm height
- Extension screw
- High speed aluminium air motor
- Specially treated cylinder walls
- Chrome pistons ensuring premium performance, durability, long-life and safety
- Filters prevent contamination of air/hydraulic system



TBDBJWA20T

20 Ton Air Bottle Jack

£299.99

Wheel Lifter



- If you need a quality wheel lifter that is affordable, extremely fast, and simply functional then look no further
- Lifts wheels directly up to and from vehicles
- Uses powerful gas springs instead of troublesome and expensive pneumatics, electrics and hydraulics
- Very little effort needed on the part of the technician
- High manoeuvrability and ergonomic design meaning installing and removing wheel assemblies couldn't be easier
- Minimise strain and maximise productivity by changing the hardest job in the tyre shop into the easiest

TBD11WL

Wheel Lifter

£499.99

Tyre & Wheel Cart



- 200kg lifting capacity
- Holds 14" - 20" wheels
- High quality construction
- Patented tilting system
- Push-Slide secure locking
- Non-marking durable wheels with industrial bearings
- Powder coated steel frame
- Weighs only 20kg

TBDWCART

Tyre & Wheel Cart

£199.99

Lite Align 8CCD Computerised Wheel Aligner

The LA850C from Lite Align is a super fast 8CCD computerised wheel alignment system suitable for use in tyre shops and other workshops. LA850C measures a complete range of vehicle geometry angles.

The user friendly software guides you through the alignment process. All measurements taken are compared with the manufacturer's specification and included on the printout.

The database carries over 15,000 vehicles with the option to create your own specific vehicle database. All measurements are to industry recognised tolerances. Inspection results can be stored, archived and printed.

Haweka Pro-Clamps

Pro-clamps are included as standard. Their precise positioning mechanism means that no run-out compensation is needed. The feet are made of engineering plastic so alloy rims are protected.

Includes:

- 4 x Wheel Mounted Camera Units
- 1 x Litealign Blue Cabinet
- 1 x Pair of Turnplates
- 1 x Brake Pedal Depressor
- 1 x Steering Wheel Lock
- 4 x Haweka Proclamps
- Windows PC with 24" Monitor
- Printer
- Delivery, Installation & User Training

Contact us
to arrange a
FREE
demo!

TBDWA200
ONLY
£7,750
or **£44.71 a week**



Lite Align 650 Series Computer 4 Wheel Laser Aligner

- Measures individual toe, set back, caster, camber, SAI, thrust line & steering wheel position
- Live readings on computer screen when linked to a computer (computer not supplied)
- Live readings displayed on gauges can be used without computer
- Tutorial adjustment screens
- Before and after printout facility
- On rack charging battery operation (no cables)
- Unique ultra low measuring position on front heads (Enables use on vehicles with low under body clearance)
- Fits on practically all car and light commercial vehicles
- Fits wheel sizes 12 to 22 inch (dependent on tyre size)
- Optional larger heads and rim buttons available
- Optional accessories include 4x4 kit and domed wheel kit
- Install and training included
- Built and designed in the UK with a 2 year warranty

LA-650
ONLY
£3,395
or **£19.59 a week**



Lite Align 450 Series 4 Wheel Laser Aligner

- Measures individual toe, set back, thrust line & steering wheel position
- Battery operation (no cables)
- Unique ultra low measuring position on front heads (enables use on vehicles with low under body clearance)
- Magnetic optional Camber/ Caster gauge available
- Fits on practically all car and light commercial vehicles
- Fits wheel sizes 12 to 22 inch (dependent on tyre size)
- Optional larger heads and rim buttons available
- Optional accessories include 4x4 kit and domed wheel kit
- Built and designed in the UK with a 2 year warranty



LA-450
ONLY
£1,649
or **£9.51 a week**

Lifting Equipment

QuickJack is a portable car lift system unlike any car jack you've ever seen. QuickJack makes vehicle maintenance on and off the track convenient and lightning fast. Unlike traditional car jacks, QuickJack lifts your vehicle 20" off the ground while you simply hold down a pendant remote control button. QuickJack is unique for a portable car lift, with two, 14-gauge steel frames that slide under each side of your vehicle. Plus, no cross beams whatsoever means you get clear undercarriage access.



The QuickJack Portable Car Lift



Item No.	TBD3500SLX	TBD5000SLX	TBD7000SLX
Lifting Capacity	1.5 Tonne	2 Tonne	3 Tonne
Max Lifting Height	20" / 508mm	21" / 533mm	21.5" / 546mm
Max Lifting Point	50.5" / 1283mm	60" / 1524mm	60" / 1524mm
Min Lifting Point	26.7" / 678mm	31.5" / 800mm	31.5" / 800mm
Price	12V £999	12V £1,299	12V £1,449

240V available upon request

Unite High Rise Scissor Lift

The Unite UB30Y High Rise Scissor Lift is suitable for various types of automobile and is ideal for many garage set ups as it does not require ground pits. This lift is the largest of the Unite lifting range and has an impressive lifting capacity of 3000kg, with a maximum lifting height of 1850mm. Featuring a pneumatic wide-teeth, self-locking insurance system as well as an anti-explosion pipe, this system will ensure complete safety and reliability.



Technical Specification

Lifting Capacity	3000kg
Lifting Height	1850mm
Platform Height	105mm
Platform Length	1450mm - 2050mm
Platform Width	635mm
Total Width	2030mm
Total Length	2050mm
Lifting Speed	55 seconds
Dropping Speed	55 seconds
Phase / AMP	1 PH / 16 AMP
Motor Power	2.2kw
Noise	70dB

TBDUB30Y ONLY £2,599
or £14.99 a week

Launch 4 Ton 2 Post Vehicle Lift

Technical Specification

Capacity	4.0 Ton (single or 3 phase)
Lifting Height	1850mm
Passing Width	2486mm
Overall Height	2900mm
Overall Width	3370mm
Lifting Time	50 seconds
Lowering Time	40 seconds
Motor Power	2.2kw
Phase / AMP	3 PH / 32 AMP 1 PH / 16 AMP
Noise	75dB

TBDEL4TS

ONLY £1,899*
or £10.96 a week

*Price for collection only.

- CE/TUV approved
- Concealed electric cables and oil pipes
- Electromagnetic safety locking system
- Double hydraulic cylinders, drive chain and chain wheels give even lifting and lowering
- Guard to cover chain and chain wheel to ensure safe operation
- Electromechanical top limit switch to prevent hydraulic system overload
- Safety cable system to keep lifting arms synchronised
- Lift suitable for low ground clearance vehicles
- Full rubber door guards
- Rubber jacking point on upper arm



Nitrogen Inflation

Nitrogen Inflation means less pressure loss through the tyre resulting in better tyre performance, reduced fuel consumption and safer motoring.

IN2FLATE 58 lpm Nitrogen Generator With Manual Inflation

The TBD58CK produces Nitrogen at 58 litres per minute at 8 bar and requires manual inflation.

Includes

- PCL MK4 Inflation Gauge
- 15 Metre Retractable Hose
- Standard Airline Connector
- 500 Green Valve Caps
- 100 Nitrogen Booklets

TBD58CK
ONLY
£999



IN2FLATE 90 lpm Nitrogen Generator with Manual Inflation

The TBD90 produces Nitrogen at 90 litres per minute at 8 bar and requires manual inflation.

Includes

- PCL MK4 Inflation Gauge
- 15 Metre Retractable Hose
- Standard Airline Connector
- 500 Green Valve Caps
- 100 Nitrogen Booklets

TBD90STOCK
ONLY
£1,199



IN2FLATE 58 lpm Nitrogen Generator with Digital Inflation and Purge Function

The TBD58D produces Nitrogen at 58 litres per minute at 8 bar and offers digital inflation and purge function.

Includes

- PCL MK4 Inflation Gauge
- 15 Metre Retractable Hose
- Standard Airline Connector
- 500 Green Valve Caps
- 100 Nitrogen Booklets

TBD58DCOM
ONLY
£1,199



Why choose IN2FLATE Nitrogen?

IN2FLATE Nitrogen generators are the result of over 20 years research and development in the highest level motorsport (Formula 1 Grand Prix) and retail environments. Tyre Bay Direct are Europe's largest Nitrogen inflation system suppliers with installations in Halfords Auto Centres, Kwik Fit, Stapletons, Merit Tyre, Selecta Tyre and thousands of dealership and fast fit centres.

The IN2FLATE system has been designed as an onsite Nitrogen generator providing an endless supply of high purity Nitrogen, perfect for tyre inflation. Available in a variety of models to suit all applications. Why not add Nitrogen tyre inflation to your services to increase your revenue and offer your customers the very best inflation mixture available.

THE DIFFERENCE WITH NITROGEN

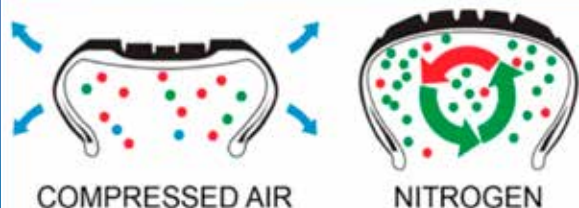

SIP Compressors

Our range of SIP compressors meet the needs of all users - from trade models designed for small workshop and garage operations, through to powerful and reliable professional models, right up to heavy-duty industrial machines suitable for the most demanding of applications.

Airmate 3HP/150-SRB Air Compressor



TBDSIP150

Airmate 3hp 150 Litre 1 PH Air Compressor

£476.99

Airmate 3HP/200-SRB Air Compressor



TBDSIP200

Airmate 3hp 200 Litre 1 PH Air Compressor

£529.99

Airmate B3800/270 Tandem Compressor



TBDSIP270

Airmate 270 Litre Air Compressor with Two 3hp Motors

£1,589.99

Airmate ISHP5.5/150 Honda Engine Petrol Compressor

Electric Start version for an extra £233



TBDSIP150P

Airmate 5.5hp 150 Litre Honda Engine Petrol Compressor

£1,229.99

Airmate B3800/3M/100 Silenced Compressor



TBDSIP3M

Airmate 100 Litre Silenced Compressor

£899.99

Mercury Mech 4.0-08-200 Screw Compressor



TBDSIPMECH

Mercury MECH 200 Litre Screw Compressor

£2,099.99

Item No.	TBDSIP150	TBDSIP200	TBDSIP270	TBDSIP150P	TBDSIP3M	TBDSIPMECH
Capacity CFM (L/min)	13	13	32	15	14	20.5
Pressure bar (psi)	145	145	145	150	145	116
Motor Kw	3hp	3hp	2x 3hp	5.5hp	3hp	5.5hp
Receiver Litres:	150	200	210	150	100	200
Power Supply	1 PH	1 PH	1 PH	-	1 PH	3 PH
Price	£479.99	£529.99	£1,589.99	£1,229.99	£899.99	£2,099.99

Like what you see?

Why not consider our flexible finance options?

Example Equipment Value £2,500

3 Year Lease	
Weekly Payment	£20.59
First Payment	£89.21
35 Payments	£89.21
Total Cost	£3211.56

4 Year Lease	
Weekly Payment	£16.25
First Payment	£70.43
47 Payments	£70.43
Total Cost	£3380.64

5 Year Lease	
Weekly Payment	£13.67
First Payment	£59.25
59 Payments	£59.25
Total Cost	£3555

Tax Relief @ 20%	£642.31
Net Cost of Finance	£2569.25

Tax Relief @ 20%	£676.13
Net Cost of Finance	£2704.51

Tax Relief @ 20%	£711
Net Cost of Finance	£2844

*The illustration above is subject to status and approval.



Tyre Bay Direct

Terms and conditions

Prices effective from 1st June 2017 and supersedes all other prices and offers to date. Prices subject to change without notice.

*Free delivery on all orders over £50 and under 30kg to mainland UK (excluding Highlands). All orders below £50 please add £4.95 carriage. Orders must be placed by 3pm for next working day delivery. Saturday delivery is available at an additional charge. Carriage costs on orders over 30kg vary and are at the discretion of Tyre Bay Direct. Items ordered in error may be returned for credit, subject to condition, but will be subject to a 20% handling and administration fee.

Tyre Bay Direct reserve the right to alter prices at any time without prior notice.

View our website for full terms and conditions of trading.

Pay monthly prices displayed are an estimate only and are subject to terms and conditions. Credit facilities are only available for orders of at least £1,000 ex VAT and are subject to status.

All pictures are for illustration purposes only and may vary slightly from the actual product supplied.

All prices, including carriage, are subject to VAT.

Head office:
Atlas Equipment Ltd,
Old Forge Road Business Centre,
Little Forge Road,
Redditch, B98 7SF



Order now on
0845 900 2130
or **01527 883 580**
or order online 24 hours a day, 7 days a week at
www.tyrebaydirect.com